

Morris Drive @ Ambassador Avenue

Thursday, November 26, 2020



The data presented here is for information purposes only and should not be considered authoritative for construction, geotechnical, engineering, navigational, legal, or other site-specific uses. The information shared is owned by the Transportation Division of the Engineering Department at the District of Saanich. Accuracy is not guaranteed.

Major Route: Morris Drive
Minor Route: Ambassador Avenue
Municipality: Saanich
Filename: Morris Dr @ Ambassador Ave-Nov 26, 2020.xlsx
Location #: TIN000997
Count ID: 2020041
Date: November 26, 2020
Day-of-week: Thursday

East/West Route: Ambassador Avenue
Intersection Type: 4-leg
Signalized?: No
Weather: Overcast and dry

Vehicle Classifications: Vehicles and Peds
 Bikes

This data is for Vehicles and Peds

Shift	Start	End	Duration
AM	7:30	9:30	2.00
MD			
PM	15:30	18:30	3.00
Total	7:30	18:30	5.00

Notes: 24-hour clock used for reporting (15-minute increments)
 North Approach - southbound vehicles approaching intersection from the north
 15x4 - 15 min volume (from maximum 15 minute period of movement/approach in peak hour period [*]) x 4
 Pedestrians - N indicates pedestrians crossing north approach (east/west)

Comments:

Time Period Begins	Morris Dr				Morris Dr				Ambassador Ave				Ambassador Ave				Total Volume		Ped DL	Crosswalks				
	NORTH Approach				SOUTH Approach				WEST Approach				EAST Approach				15-min	Hour		N	S	W	E	
	Left	Thru	Right	Total	Left	Thru	Right	Total	Left	Thru	Right	Total	Left	Thru	Right	Total								
7:30	0	8	1	9	1	6	0	7	2	0	3	5	0	0	0	0	0	21			0	2	0	2
7:45	0	5	1	6	0	10	0	10	7	0	5	12	0	0	0	0	0	28			0	4	3	1
8:00	0	14	7	21	2	36	0	38	11	1	4	16	0	0	0	0	0	75	*		0	2	2	4
8:15	0	48	8	56	3	54	2	59	9	2	4	15	0	1	0	1	131	255	+		2	13	4	16
8:30	0	31	11	42	5	26	13	44	11	5	4	20	5	4	0	9	115	349	*		0	20	3	23
8:45	0	25	3	28	5	13	0	18	2	0	4	6	7	2	0	9	61	382	*		0	13	4	13
9:00	0	8	3	11	3	10	3	16	4	0	7	11	1	3	0	4	42	349			0	2	1	5
9:15	0	3	2	5	4	9	0	13	2	0	3	5	0	1	0	1	24	242			0	1	0	2
n/a																								
n/a																								
n/a																								
n/a																								
n/a																								
n/a																								
n/a																								
n/a																								
n/a																								
n/a																								
n/a																								
n/a																								
n/a																								
Total	0	142	36	178	23	164	18	205	48	8	34	90	13	11	0	24	497				2	57	17	66

n/a																								
n/a																								
n/a																								
n/a																								
n/a																								
n/a																								
n/a																								
n/a																								
n/a																								
n/a																								
n/a																								
n/a																								
n/a																								
n/a																								
n/a																								
n/a																								
n/a																								
n/a																								
Total																								

n/a																								
n/a																								
n/a																								
n/a																								
n/a																								
n/a																								
n/a																								
n/a																								
n/a																								
n/a																								
n/a																								
n/a																								
n/a																								
n/a																								
n/a																								
n/a																								
n/a																								
n/a																								
Total	2	146	37	185	31	103	4	138	54	2	50	106	6	1	1	8	437				0	19	29	25

AM Peak Period
Vehicles and Peds

Time Period Begins	Morris Dr NORTH Approach				Morris Dr SOUTH Approach				Ambassador Ave WEST Approach				Ambassador Ave EAST Approach				Total Volume		Total Ped	Crosswalks				Conflict	
	Left	Thru	Right	Total	Left	Thru	Right	Total	Left	Thru	Right	Total	Left	Thru	Right	Total	15-min	Hour		N	S	W	E	15 min	Hr
7:30	0	8	1	9	1	6	0	7	2	0	3	5	0	0	0	0	21		0	2	0	2	13		
7:45	0	5	1	6	0	10	0	10	7	0	5	12	0	0	0	0	28		0	4	3	1	17		
8:00	0	14	7	21	2	36	0	38	11	1	4	16	0	0	0	0	75	*	0	2	2	4	47		
8:15	0	48	8	56	3	54	2	59	9	2	4	15	0	1	0	1	131	255+	2	13	4	16	69	146	
8:30	0	31	11	42	5	26	13	44	11	5	4	20	5	4	0	9	115	349*	0	20	3	23	62	195	
8:45	0	25	3	28	5	13	0	18	2	0	4	6	7	2	0	9	61	382*	0	13	4	13	44	222	
9:00	0	8	3	11	3	10	3	16	4	0	7	11	1	3	0	4	42	349	0	2	1	5	22	197	
9:15	0	3	2	5	4	9	0	13	2	0	3	5	0	1	0	1	24	242	0	1	0	2	12	140	
n/a																									
n/a																									
n/a																									
n/a																									
n/a																									
n/a																									
n/a																									
n/a																									
n/a																									
n/a																									
n/a																									
n/a																									
n/a																									
n/a																									
n/a																									
n/a																									

Total	0	142	36	178	23	164	18	205	48	8	34	90	13	11	0	24	497		2	57	17	66	260
Avg Hr	0	71	18	89	12	82	9	103	24	4	17	45	7	6	0	12	249		1	29	9	33	

Peak hour of the intersection

Pk Hr	0	118	29	147	15	129	15	159	33	8	16	57	12	7	0	19	382*		2	48	13	56	202
15x4	0	192	44	224	20	216	52	236	44	20	16	80	28	16	0	36	524+		8	80	16	92	332
PHF	n/a	0.61	0.66	0.66	0.75	0.60	0.29	0.67	0.75	0.40	1.00	0.71	0.43	0.44	n/a	0.53	0.73		0.25	0.60	0.81	0.61	0.61

Peak hour of conflicting volumes for the intersection

Pk Hr	0	118	29	147	15	129	15	159	33	8	16	57	12	7	0	19	382*		2	48	13	56	202
15x4	0	192	44	224	20	216	52	236	44	20	16	80	28	16	0	36	524+		8	80	16	92	332
PHF	n/a	0.61	0.66	0.66	0.75	0.60	0.29	0.67	0.75	0.40	1.00	0.71	0.43	0.44	n/a	0.53	0.73		0.25	0.60	0.81	0.61	0.61

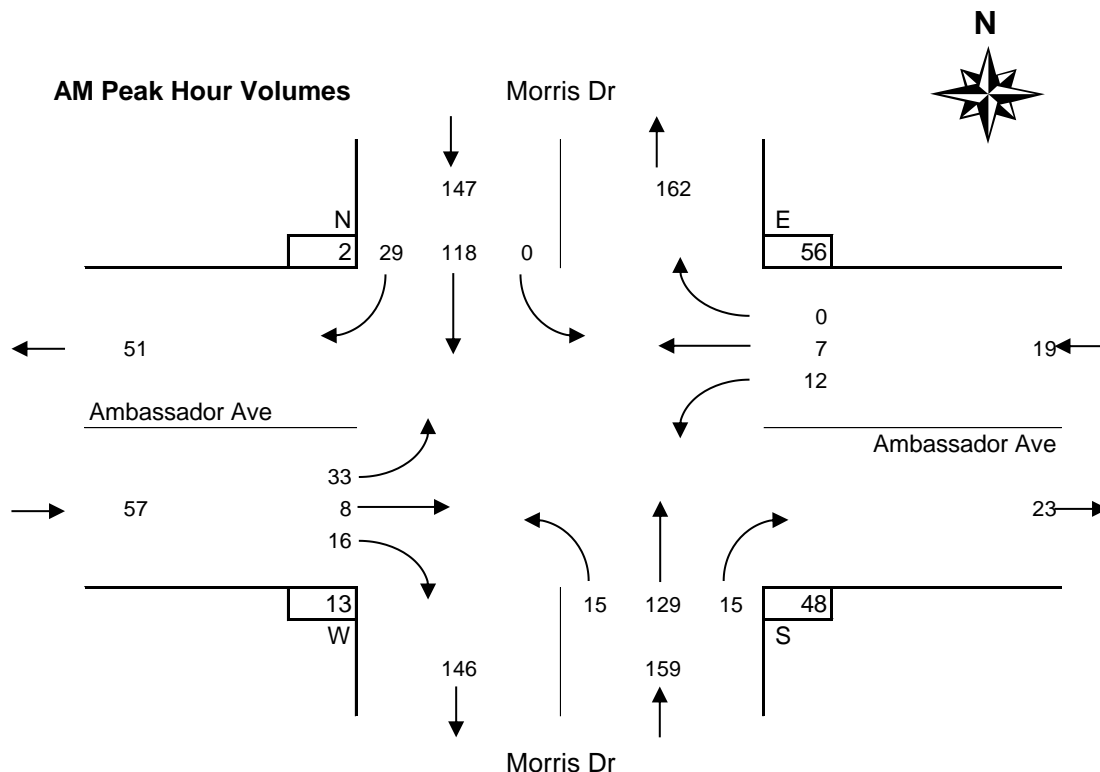

Time Period Begins	Morris Dr NORTH Approach				Morris Dr SOUTH Approach				Ambassador Ave WEST Approach				Ambassador Ave EAST Approach				Total Volume		Pedestrians	Crosswalks				Conflict	
	Left	Thru	Right	Total	Left	Thru	Right	Total	Left	Thru	Right	Total	Left	Thru	Right	Total	15-min	Hour		N	S	W	E	15 min	Hr
n/a																									
n/a																									
n/a																									
n/a																									
n/a																									
n/a																									
n/a																									
n/a																									
n/a																									
n/a																									
n/a																									
n/a																									
n/a																									
n/a																									

Total																								
Avg Hr																								

Peak hour of the intersection

Pk Hr																								
15x4																								
PHF																								

Peak hour of conflicting volumes for the intersection

Pk Hr																								
15x4																								
PHF																								

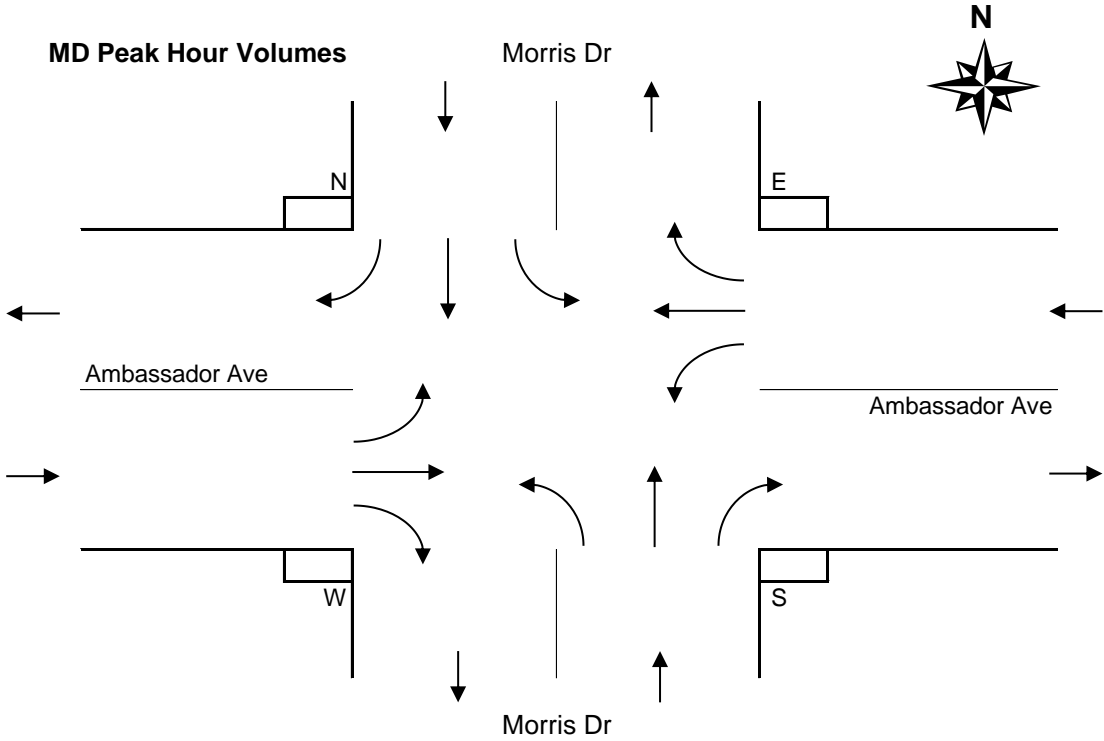

Time Period Begins	Morris Dr				Morris Dr				Ambassador Ave				Ambassador Ave				Total Volume		Ped	Crosswalks				Conflict	
	NORTH Approach				SOUTH Approach				WEST Approach				EAST Approach				15-min	Hour		N	S	W	E	15 min	Hr
15:30	0	30	9	39	7	18	2	27	12	1	7	20	2	0	0	2	88	+	0	10	1	6	58		
15:45	1	26	7	34	3	14	1	18	7	0	5	12	1	1	0	2	66	*	0	1	2	2	44		
16:00	0	10	2	12	5	5	0	10	1	0	5	6	1	0	0	1	29	*	0	2	2	4	23		
16:15	0	13	1	14	4	10	0	14	0	0	6	6	0	0	0	34	217*	0	4	2	1	24	149		
16:30	0	9	4	13	2	7	0	9	2	0	7	9	0	0	0	31	160		0	0	6	1	22	113	
16:45	1	5	2	8	1	9	0	10	7	0	2	9	0	0	1	28	122		0	0	5	1	18	87	
17:00	0	20	4	24	1	15	0	16	4	1	3	8	1	0	0	49	142		0	0	1	0	30	94	
17:15	0	11	1	12	2	6	1	9	3	0	3	6	1	0	0	28	136		0	0	0	1	18	88	
17:30	0	5	2	7	1	5	0	6	10	0	6	16	0	0	0	29	134		0	2	3	2	18	84	
17:45	0	8	2	10	3	4	0	7	3	0	3	6	0	0	0	23	129		0	0	2	3	16	82	
18:00	0	7	3	10	2	7	0	9	5	0	0	5	0	0	0	24	104		0	0	4	4	17	69	
18:15	0	2	0	2	0	3	0	3	0	0	3	3	0	0	0	8	84		0	0	1	0	6	57	
n/a																									
n/a																									
n/a																									
n/a																									
n/a																									
n/a																									
n/a																									
n/a																									
n/a																									
n/a																									

Total	2	146	37	185	31	103	4	138	54	2	50	106	6	1	1	8	437		0	19	29	25	272
Avg Hr	1	49	12	62	10	34	1	46	18	1	17	35	2	0	0	3	146		0	6	10	8	

Peak hour of the intersection

Pk Hr	1	79	19	99	19	47	3	69	20	1	23	44	4	1	0	5	217*		0	17	7	13	145
15x4	4	120	36	156	28	72	8	108	48	4	28	80	8	4	0	8	352*		0	40	8	24	236
PHF	0.25	0.66	0.53	0.63	0.68	0.65	0.38	0.64	0.42	0.25	0.82	0.55	0.50	0.25	n/a	0.63	0.62		n/a	0.43	0.88	0.54	0.61

Peak hour of conflicting volumes for the intersection

Pk Hr	1	79	19	99	19	47	3	69	20	1	23	44	4	1	0	5	217*		0	17	7	13	145
15x4	4	120	36	156	28	72	8	108	48	4	28	80	8	4	0	8	352*		0	40	8	24	236
PHF	0.25	0.66	0.53	0.63	0.68	0.65	0.38	0.64	0.42	0.25	0.82	0.55	0.50	0.25	n/a	0.63	0.62		n/a	0.43	0.88	0.54	0.61

** Calculated peak hour occurs during the first or last hour of shift and therefore may be invalid. ** N

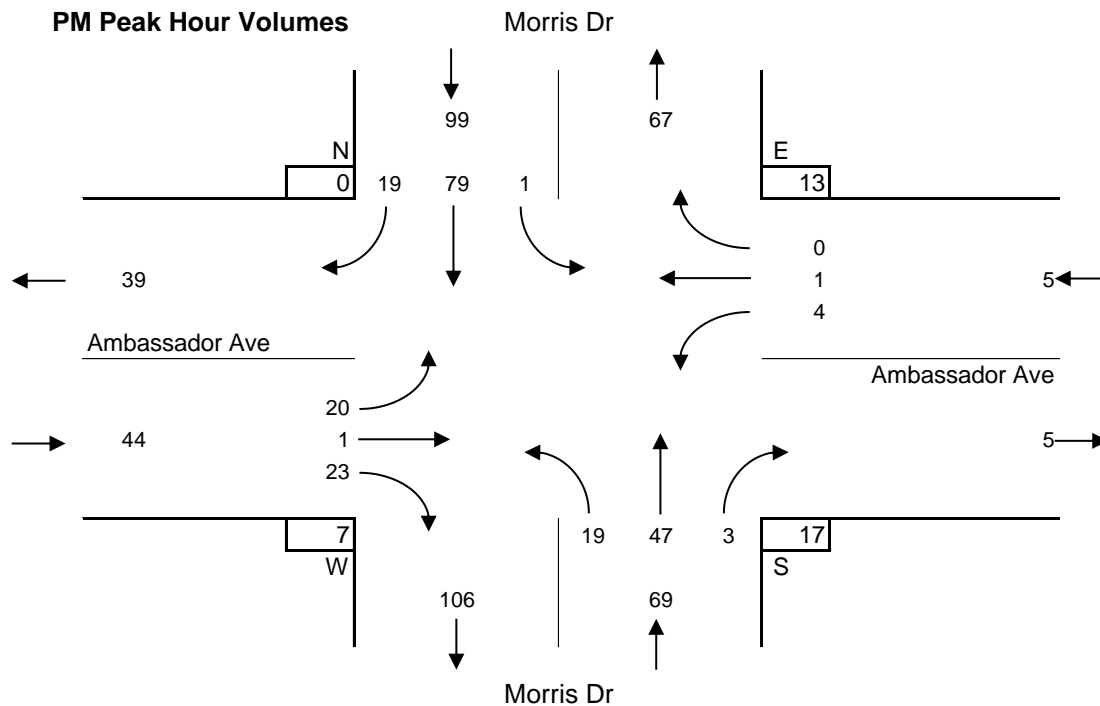

Entire Survey Period

5 Hours

	Morris Dr				Morris Dr				Ambassador Ave				Ambassador Ave				Total Volume	Crosswalks			
	NORTH Approach				SOUTH Approach				WEST Approach				EAST Approach					N	S	W	E
	Left	Thru	Right	Total	Left	Thru	Right	Total	Left	Thru	Right	Total	Left	Thru	Right	Total					
Total	2	288	73	363	54	267	22	343	102	10	84	196	19	12	1	32	934	2	76	46	91
Avg Hr	0	58	15	73	11	53	4	69	20	2	17	39	4	2	0	6	187	0	15	9	18

AM Peak Period

2 Hours

	Morris Dr				Morris Dr				Ambassador Ave				Ambassador Ave				Total Volume	Crosswalks			
	NORTH Approach				SOUTH Approach				WEST Approach				EAST Approach					N	S	W	E
	Left	Thru	Right	Total	Left	Thru	Right	Total	Left	Thru	Right	Total	Left	Thru	Right	Total					
Totals	0	142	36	178	23	164	18	205	48	8	34	90	13	11	0	24	497	2	57	17	66
Avg Hr	0	71	18	89	12	82	9	103	24	4	17	45	7	6	0	12	249	1	29	9	33

MD Peak Period

Hours

	Morris Dr				Morris Dr				Ambassador Ave				Ambassador Ave				Total Volume	Crosswalks				
	NORTH Approach				SOUTH Approach				WEST Approach				EAST Approach					N	S	W	E	
	Left	Thru	Right	Total	Left	Thru	Right	Total	Left	Thru	Right	Total	Left	Thru	Right	Total						
Totals																						
Total																						
Avg Hr																						

PM Peak Period

3 Hours

	Morris Dr				Morris Dr				Ambassador Ave				Ambassador Ave				Total Volume	Crosswalks			
	NORTH Approach				SOUTH Approach				WEST Approach				EAST Approach					N	S	W	E
	Left	Thru	Right	Total	Left	Thru	Right	Total	Left	Thru	Right	Total	Left	Thru	Right	Total					
Totals	2	146	37	185	31	103	4	138	54	2	50	106	6	1	1	8	437	0	19	29	25
Avg Hr	1	49	12	62	10	34	1	46	18	1	17	35	2	0	0	3	146	0	6	10	8

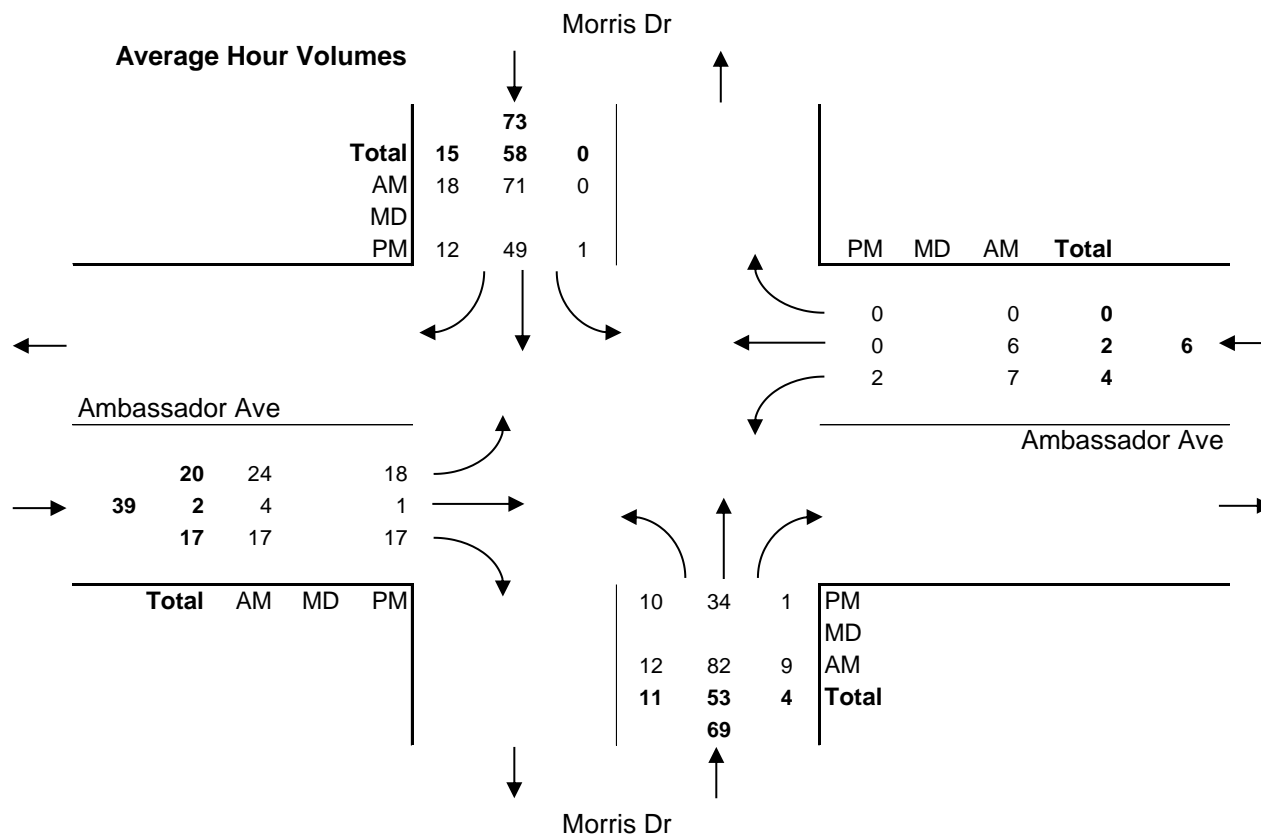

Major Route: Morris Drive
Minor Route: Ambassador Avenue
Municipality: Saanich
Filename: Morris Dr @ Ambassador Ave-Nov 26, 2020.xlsx
Location #: TIN000997
Count ID: 2020041
Date: November 26, 2020
Day-of-week: Thursday

East/West Route: Ambassador Avenue
Intersection Type: 4-leg
Signalized?: No
Weather: Overcast and dry

Vehicle Classifications: Vehicles and Peds **This data is for Bikes**
 Bikes

Shift	Start	End	Duration
AM	7:30	9:30	2.00
MD			
PM	15:30	18:30	3.00
Total	7:30	18:30	5.00

Notes: 24-hour clock used for reporting (15-minute increments)
 North Approach - southbound vehicles approaching intersection from the north
 15x4 - 15 min volume (from maximum 15 minute period of movement/approach in peak hour period [*]) x 4
 Pedestrians - N indicates pedestrians crossing north approach (east/west)

Comments:

Survey Data
Bikes

Morris Drive @ Ambassador Avenue
Thursday, November 26, 2020

Time Period Begins	Morris Dr NORTH Approach				Morris Dr SOUTH Approach				Ambassador Ave WEST Approach				Ambassador Ave EAST Approach				Total Volume		PL				
	Left	Thru	Right	Total	Left	Thru	Right	Total	Left	Thru	Right	Total	Left	Thru	Right	Total	15-min	Hour		N	S	W	E
7:30	0	1	0	1	0	0	0	0	0	1	0	1	0	0	0	0	2		0	0	0	0	
7:45	0	0	0	0	0	0	0	0	0	0	1	1	0	0	0	0	1		0	0	0	0	
8:00	0	0	0	0	0	1	0	1	0	0	0	0	1	0	0	1	2		0	0	0	0	
8:15	0	0	0	0	3	0	0	3	0	0	0	0	0	0	0	0	3	8*	0	0	0	0	
8:30	0	1	0	1	1	0	0	1	0	0	2	2	0	0	0	0	4	10+	0	0	0	0	
8:45	1	1	0	2	0	0	0	0	0	0	0	0	0	0	0	0	2	11*	0	0	0	0	
9:00	0	1	1	2	0	1	0	1	0	0	0	0	0	0	0	0	3	12*	0	0	0	0	
9:15	0	0	0	0	0	0	0	0	0	0	0	0	0	0	0	0	0	9		0	0	0	
n/a																							
n/a																							
n/a																							
n/a																							
n/a																							
n/a																							
n/a																							
n/a																							
n/a																							
n/a																							
n/a																							
n/a																							
Total	1	4	1	6	4	2	0	6	0	1	3	4	0	1	0	1	17		0	0	0	0	

n/a																						
n/a																						
n/a																						
n/a																						
n/a																						
n/a																						
n/a																						
n/a																						
n/a																						
n/a																						
n/a																						
n/a																						
n/a																						
n/a																						
n/a																						
Total																						

15:30	0	0	0	0	0	0	0	0	0	0	0	0	0	0	0	0	0		0	0	0	0
15:45	0	0	0	0	0	0	0	0	0	0	0	0	0	0	0	0	0		0	0	0	0
16:00	0	1	0	1	0	2	0	2	0	0	0	0	0	0	0	0	3		*	0	0	0
16:15	0	1	0	1	0	1	1	2	0	0	1	1	0	1	0	1	5	8+	0	0	0	0
16:30	0	1	0	1	0	0	0	0	0	0	0	0	0	0	0	0	1	9*	0	0	0	0
16:45	0	1	0	1	1	0	0	1	0	0	0	0	0	0	0	0	2	11*	0	0	0	0
17:00	0	0	0	0	0	0	0	0	0	0	0	0	1	0	0	1	1	9	0	0	0	0
17:15	0	0	0	0	0	1	0	1	0	0	0	0	0	0	0	0	1	5	0	0	0	0
17:30	0	0	0	0	1	0	0	1	0	0	0	0	0	0	0	0	1	5	0	0	0	0
17:45	0	0	0	0	0	1	0	1	0	0	0	0	0	0	0	0	1	4	0	0	0	0
18:00	0	0	0	0	0	0	0	0	0	0	0	0	0	0	0	0	0	3	0	0	0	0
18:15	0	0	0	0	0	0	0	0	0	0	0	0	0	0	0	0	0	2	0	0	0	0
n/a																						
n/a																						
n/a																						
n/a																						
n/a																						
n/a																						
n/a																						
n/a																						
Total	0	4	0	4	2	5	1	8	0	0	1	1	1	1	0	2	15		0	0	0	0

Time Period Begins	Morris Dr				Morris Dr				Ambassador Ave				Ambassador Ave				Total Volume		Speed	Conflict				
	NORTH Approach				SOUTH Approach				WEST Approach				EAST Approach							N	S	W	E	
7:30	0	1	0	1	0	0	0	0	0	1	0	1	0	0	0	0	2		0	0	0	0	2	
7:45	0	0	0	0	0	0	0	0	0	0	1	1	0	0	0	0	1		0	0	0	0	1	
8:00	0	0	0	0	0	1	0	1	0	0	0	0	0	1	0	1	2		0	0	0	0	2	
8:15	0	0	0	0	3	0	0	3	0	0	0	0	0	0	0	0	3	8*	0	0	0	0	3	8
8:30	0	1	0	1	1	0	0	1	0	0	2	2	0	0	0	0	4	10+	0	0	0	0	4	10
8:45	1	1	0	2	0	0	0	0	0	0	0	0	0	0	0	0	2	11*	0	0	0	0	1	10
9:00	0	1	1	2	0	1	0	1	0	0	0	0	0	0	0	0	3	12*	0	0	0	0	2	10
9:15	0	0	0	0	0	0	0	0	0	0	0	0	0	0	0	0	0	9	0	0	0	0	0	7
n/a																								
n/a																								
n/a																								
n/a																								
n/a																								
n/a																								
n/a																								
n/a																								
n/a																								
n/a																								
n/a																								
n/a																								
n/a																								
n/a																								
n/a																								
n/a																								

Total	1	4	1	6	4	2	0	6	0	1	3	4	0	1	0	1	17		0	0	0	0	13
Avg Hr	1	2	1	3	2	1	0	3	0	1	2	2	0	1	0	1	9		0	0	0	0	

Peak hour of the intersection

Pk Hr	1	3	1	5	4	1	0	5	0	0	2	2	0	0	0	0	12*		0	0	0	0	10
15x4	4	4	4	8	12	4	0	12	0	0	8	8	0	0	0	0	16*		0	0	0	0	28
PHF	0.25	0.75	0.25	0.63	0.33	0.25	n/a	0.42	n/a	n/a	0.25	0.25	n/a	n/a	n/a	n/a	0.75		n/a	n/a	n/a	n/a	0.36

Peak hour of conflicting volumes for the intersection

Pk Hr	0	1	0	1	4	1	0	5	0	0	3	3	0	1	0	1	10*		0	0	0	0	8
15x4	0	4	0	4	12	4	0	12	0	0	8	8	0	4	0	4	16*		0	0	0	0	24
PHF	n/a	0.25	n/a	0.25	0.33	0.25	n/a	0.42	n/a	n/a	0.38	0.38	n/a	0.25	n/a	0.25	0.63		n/a	n/a	n/a	n/a	0.33

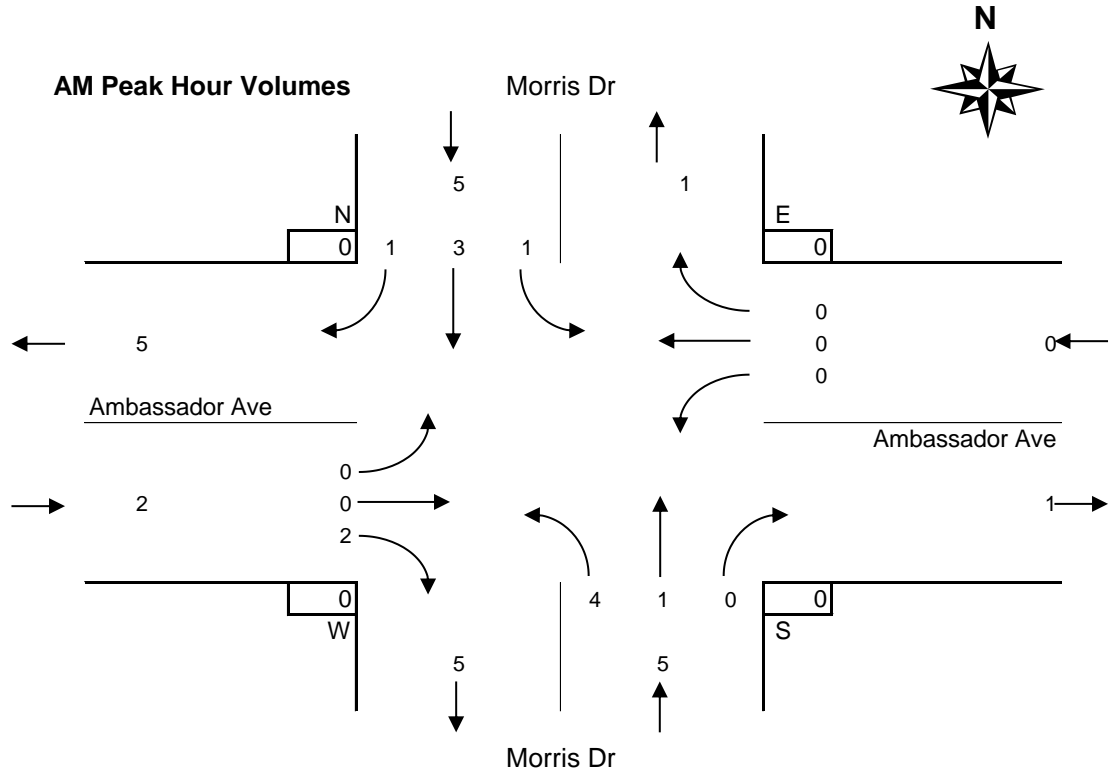

Time Period Begins	Morris Dr				Morris Dr				Ambassador Ave				Ambassador Ave				Total Volume		Pedestrians	Conflict							
	NORTH Approach				SOUTH Approach				WEST Approach				EAST Approach				15-min	Hour		N	S	W	E	15 min	Hr		
n/a																											
n/a																											
n/a																											
n/a																											
n/a																											
n/a																											
n/a																											
n/a																											
n/a																											
n/a																											
n/a																											
n/a																											
n/a																											
n/a																											
n/a																											
n/a																											
n/a																											

Total																												
Avg Hr																												

Peak hour of the intersection

Pk Hr																												
15x4																												
PHF																												

Peak hour of conflicting volumes for the intersection

Pk Hr																												
15x4																												
PHF																												

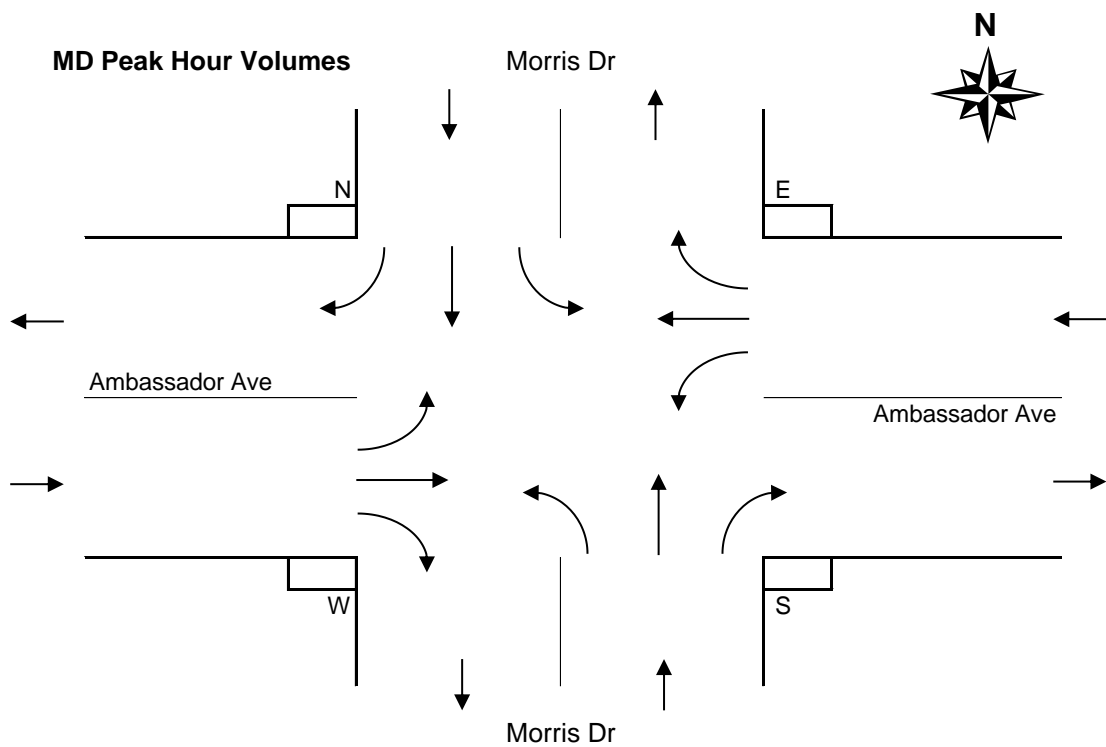

PM Peak Period
Bikes

Morris Drive @ Ambassador Avenue
Thursday, November 26, 2020

Time Period Begins	Morris Dr NORTH Approach				Morris Dr SOUTH Approach				Ambassador Ave WEST Approach				Ambassador Ave EAST Approach				Total Volume		Speed	Conflict				
	Left	Thru	Right	Total	Left	Thru	Right	Total	Left	Thru	Right	Total	Left	Thru	Right	Total	15-min	Hour		N	S	W	E	15 min
15:30	0	0	0	0	0	0	0	0	0	0	0	0	0	0	0	0	0	0	0	0	0	0	0	0
15:45	0	0	0	0	0	0	0	0	0	0	0	0	0	0	0	0	0	0	0	0	0	0	0	0
16:00	0	1	0	1	0	2	0	2	0	0	0	0	0	0	0	0	3	*	0	0	0	0	0	2
16:15	0	1	0	1	0	1	1	2	0	0	1	1	0	1	0	1	5	8+	0	0	0	0	0	3
16:30	0	1	0	1	0	0	0	0	0	0	0	0	0	0	0	0	1	9*	0	0	0	0	1	6
16:45	0	1	0	1	1	0	0	1	0	0	0	0	0	0	0	0	2	11*	0	0	0	0	2	8
17:00	0	0	0	0	0	0	0	0	0	0	0	0	1	0	0	1	1	9	0	0	0	0	1	7
17:15	0	0	0	0	0	1	0	1	0	0	0	0	0	0	0	0	1	5	0	0	0	0	1	5
17:30	0	0	0	0	1	0	0	1	0	0	0	0	0	0	0	0	1	5	0	0	0	0	1	5
17:45	0	0	0	0	0	1	0	1	0	0	0	0	0	0	0	0	1	4	0	0	0	0	1	4
18:00	0	0	0	0	0	0	0	0	0	0	0	0	0	0	0	0	0	3	0	0	0	0	0	3
18:15	0	0	0	0	0	0	0	0	0	0	0	0	0	0	0	0	0	2	0	0	0	0	0	2
n/a																								
n/a																								
n/a																								
n/a																								
n/a																								
n/a																								
n/a																								
n/a																								
n/a																								
n/a																								
n/a																								

Total	0	4	0	4	2	5	1	8	0	0	1	1	1	1	0	2	15						8
Avg Hr	0	1	0	1	1	2	0	3	0	0	0	0	0	0	0	1	5						

Peak hour of the intersection

Pk Hr	0	4	0	4	1	3	1	5	0	0	1	1	0	1	0	1	11*						6
15x4	0	4	0	4	4	8	4	8	0	0	4	4	0	4	0	4	20*						16
PHF	n/a	1.00	n/a	1.00	0.25	0.38	0.25	0.63	n/a	n/a	0.25	0.25	n/a	0.25	n/a	0.25	0.55						0.38

Peak hour of conflicting volumes for the intersection

Pk Hr	0	4	0	4	1	3	1	5	0	0	1	1	0	1	0	1	11*						6
15x4	0	4	0	4	4	8	4	8	0	0	4	4	0	4	0	4	20*						16
PHF	n/a	1.00	n/a	1.00	0.25	0.38	0.25	0.63	n/a	n/a	0.25	0.25	n/a	0.25	n/a	0.25	0.55						0.38

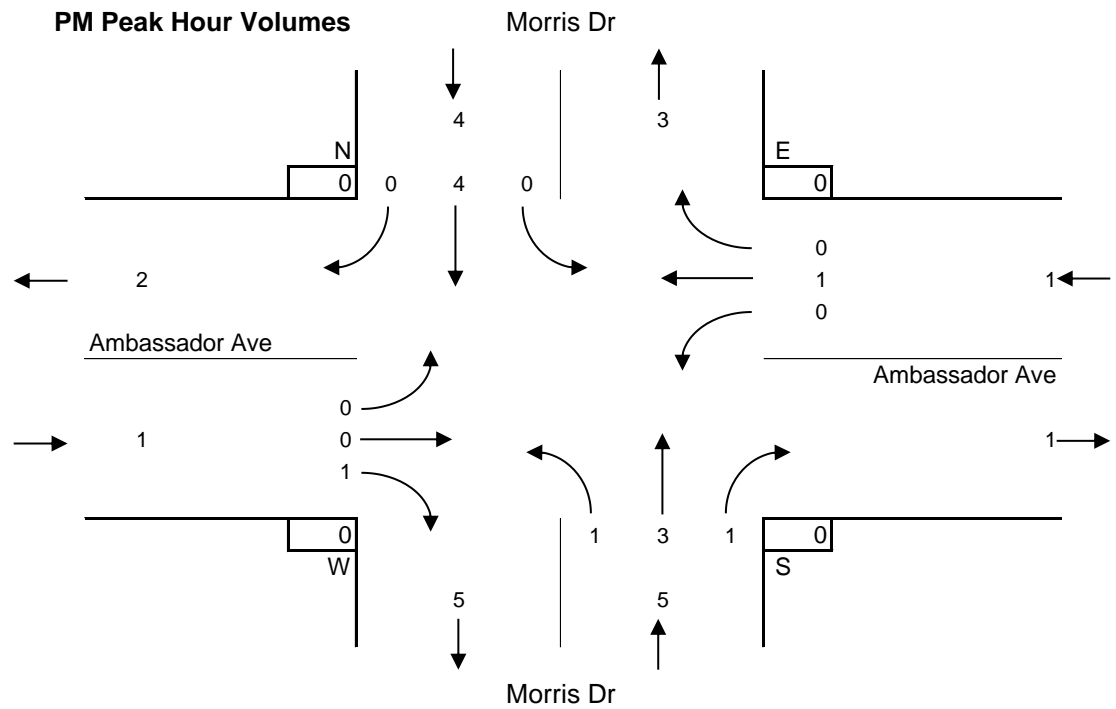

Entire Survey Period

5 Hours

	Morris Dr				Morris Dr				Ambassador Ave				Ambassador Ave				Total Volume				
	NORTH Approach				SOUTH Approach				WEST Approach				EAST Approach					N	S	W	E
	Left	Thru	Right	Total	Left	Thru	Right	Total	Left	Thru	Right	Total	Left	Thru	Right	Total					
Total	1	8	1	10	6	7	1	14	0	1	4	5	1	2	0	3	32	0	0	0	0
Avg Hr	0	2	0	2	1	1	0	3	0	0	1	1	0	0	0	1	6	0	0	0	0

AM Peak Period

2 Hours

	Morris Dr				Morris Dr				Ambassador Ave				Ambassador Ave				Total Volume				
	NORTH Approach				SOUTH Approach				WEST Approach				EAST Approach					N	S	W	E
	Left	Thru	Right	Total	Left	Thru	Right	Total	Left	Thru	Right	Total	Left	Thru	Right	Total					
Totals	1	4	1	6	4	2	0	6	0	1	3	4	0	1	0	1	17	0	0	0	0
Avg Hr	1	2	1	3	2	1	0	3	0	1	2	2	0	1	0	1	9	0	0	0	0

MD Peak Period

Hours

	Morris Dr				Morris Dr				Ambassador Ave				Ambassador Ave				Total Volume				
	NORTH Approach				SOUTH Approach				WEST Approach				EAST Approach					N	S	W	E
	Left	Thru	Right	Total	Left	Thru	Right	Total	Left	Thru	Right	Total	Left	Thru	Right	Total					
Total																					
Avg Hr																					

PM Peak Period

3 Hours

	Morris Dr				Morris Dr				Ambassador Ave				Ambassador Ave				Total Volume				
	NORTH Approach				SOUTH Approach				WEST Approach				EAST Approach					N	S	W	E
	Left	Thru	Right	Total	Left	Thru	Right	Total	Left	Thru	Right	Total	Left	Thru	Right	Total					
Totals	0	4	0	4	2	5	1	8	0	0	1	1	1	1	0	2	15	0	0	0	0
Avg Hr	0	1	0	1	1	2	0	3	0	0	0	0	0	0	0	1	5	0	0	0	0

